

IPU - Inverter With Brains

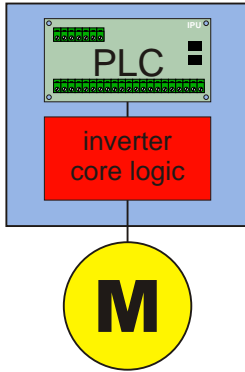

IPU is a PLC for integration with Hitachi SJ300/L300P inverter



IPU has inputs and outputs which can be used in your application

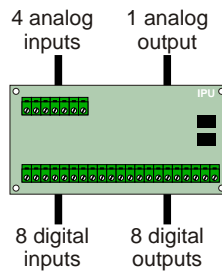

IPU is placed into inverter option slot

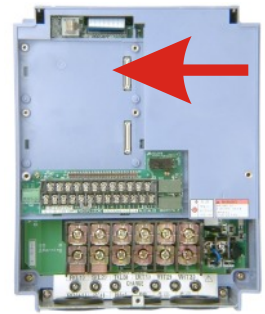

External, fully programmable operator panel is available

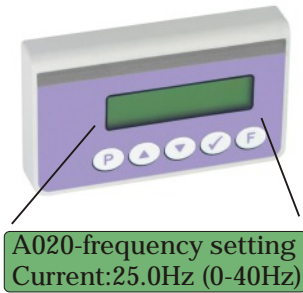

IPU is able to run custom program written according to user specifications

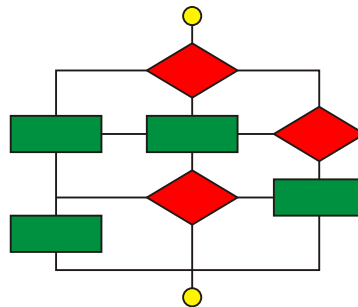

For more details about programming, please check user manual

IPU is able to read/write any inverter parameter

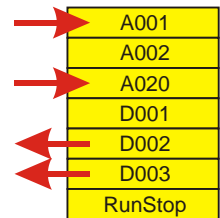

Several IPU's can be connected into a network, and controlled by operator panel

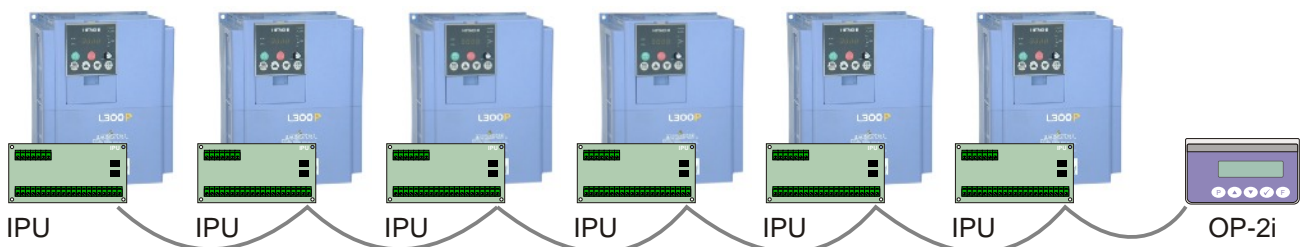

Parameter access

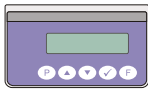

A001
A020
D001
D002

Access to selected application-specific parameters, optional password protection.

Enhanced multi-stage

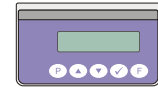
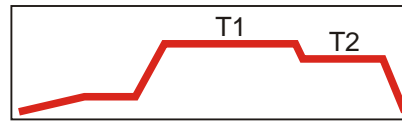

T1, T2

Multi-stage with control logic and programmable timers.

Fail-safe pump station

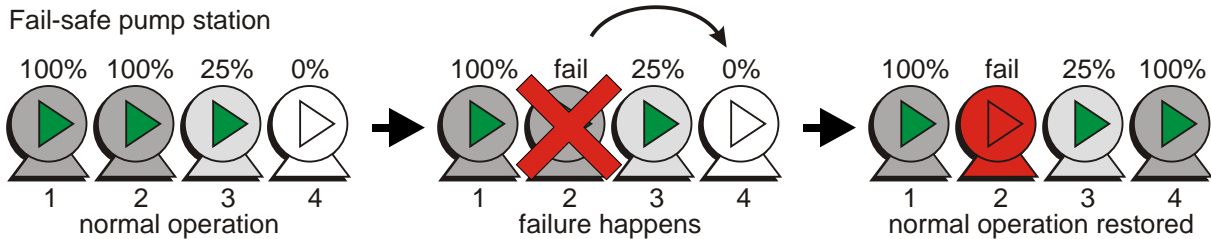

Using intelligent monitoring, failure may be detected, allowing pump-station to continue normal operation.

Equalizing operating hours

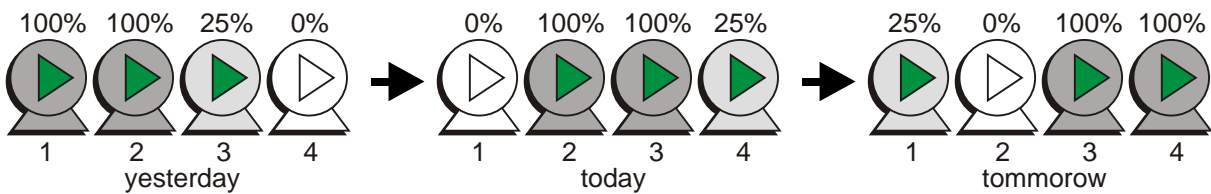

Using intelligent power-management control, inverters take care that load is evenly distributed among pumps, providing longer pump life and longer service period.

Regulation with sleep-mode

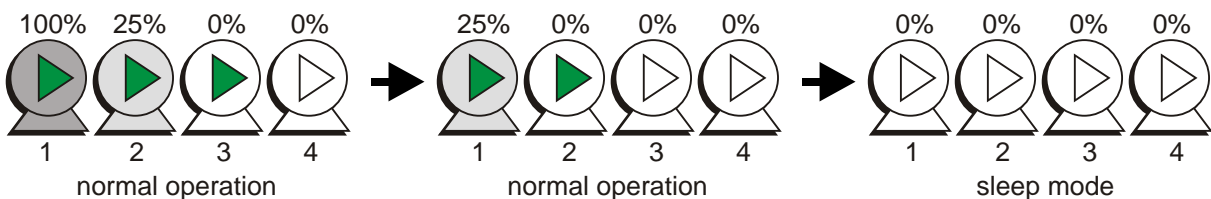

If frequency is below predefined level, IPU may automatically put inverter into sleep mode.

Dosator machine

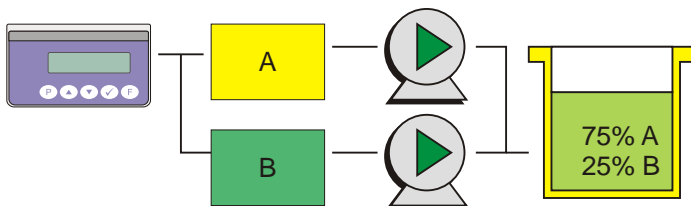

Precise dosator using hose-pump control and internal counter

Cybrotech Ltd
 14 Brinell Way
 Harfreys Industrial Estate
 Great Yarmouth
 Norfolk, Nr31 OLU - UK
 tel: +44 (0)1493 650 222
www.cybrotech.co.uk
info@cybrotech.co.uk